

detay
LIGHTING

2024 FLOODLIGHT CATALOG



detay LIGHTING

Established in 1993 in Istanbul, Detay Lighting operates in the production, sales and export of LED lighting luminaires. Detay Lighting continues its lighting journey with the vision of becoming one of the most successful companies in the lighting industry by increasing its brand value day by day.

The professional management staff, continuously developed sales channels, technical project network and the continuity of training of the sales team make a great contribution to this success.

At the same time, Detay Lighting, which provides services in the project department with its professional team of engineers and technicians, evaluates the projects on site and offers consultancy services to its customers in training and related fields.



TOKYO



BODY

Aluminium injection body, electrostatic powder coated, 4mm tempered glass, ventilation plug.

LED

100.000 hours LED lifetime according to LM-80 and TM-21 report.

DRIVER

Constant current output, With 90% efficiency, Effective power factor regulation that is not affected by fluctuations in grid voltage, dimmable-programmable ENEC certificated IP67 Driver.

LENS

Resistant to UV rays, 93% optically efficient PMMA material lens.

PCB

Aluminum PCB, Aluminum Base Layer / Thickness: 1L / 1.6mm. Copper Thickness: 1 OZ, HASL surface coating.

OPTIONS

SPD, IP68 Connector.

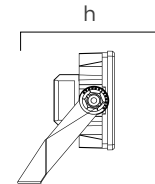
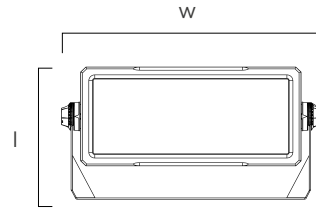

TECHNICAL SPECIFICATIONS

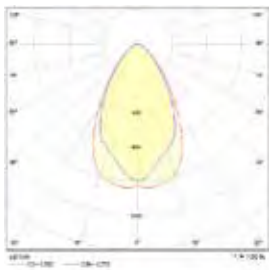

RAL CODES

Standard	Optional	Optional
RAL 9005	RAL 9016	RAL 9022

SYMMETRIC

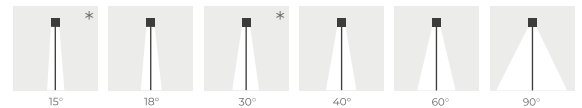

Product Code	Power	Lumen	Color Temperature	Dimensions l w h (mm)	Weight
DTY.013	240W	31200	3000-4000-6500K	300x563x209	8,3 kg
	320W	41600	3000-4000-6500K	300x563x209	8,5 kg
	240W*	28800	3000-4000-6500K	300x563x209	8,3 kg
	320W*	38400	3000-4000-6500K	300x563x209	8,5 kg

*for 3535 LED version



TOKYO



BODY

Aluminium injection body, electrostatic powder coated, 4mm tempered glass, ventilation plug.

LED

100.000 hours LED lifetime according to LM-80 and TM-21 report.

DRIVER

Constant current output, With 90% efficiency, Effective power factor regulation that is not affected by fluctuations in grid voltage, dimmable-programmable ENEC certificated IP67 Driver.

LENS

Resistant to UV rays, 93% optically efficient PMMA material lens or *PC reflector with aluminium reflective coating.

PCB

Aluminum PCB, Aluminum Base Layer / Thickness: 1L / 1.6mm. Copper Thickness: 1 OZ, HASL surface coating.

OPTIONS

SPD, IP68 Connector.

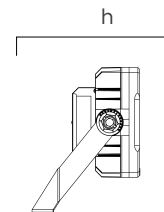
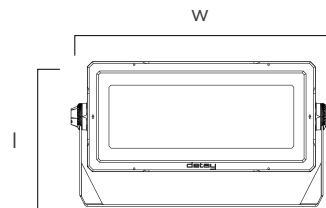

TECHNICAL SPECIFICATIONS

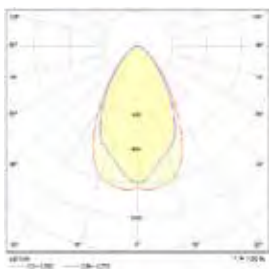

RAL CODES

Standard	Optional	Optional
RAL 9005	RAL 9016	RAL 9022

SYMMETRIC / ASYMMETRIC

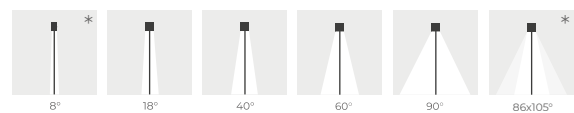

Product Code	Power	Lumen	Color Temperature	Dimensions l w h (mm)	Weight
DTY.013	400W	52000	3000-4000-6500K	345x621x255	12 kg
	500W	65000	3000-4000-6500K	345x621x255	12,5 kg
	400W*	48000	3000-4000-6500K	345x621x255	12 kg
	500W*	60000	3000-4000-6500K	345x621x255	12,5 kg

*for 80 CRI 3535 LED version

FLOODLIGHT



TOKYO



BODY

Aluminium injection body, electrostatic powder coated, 4mm tempered glass, ventilation plug.

LED

100.000 hours LED lifetime according to LM-80 and TM-21 report.

DRIVER

Constant current output, With 90% efficiency, Effective power factor regulation that is not affected by fluctuations in grid voltage, dimmable-programmable ENEC certificated IP67 Driver.

LENS

Resistant to UV rays, 93% optically efficient PMMA material lens or *PC reflector with aluminium reflective coating.

PCB

Aluminum PCB, Aluminum Base Layer / Thickness: 1L / 1.6mm. Copper Thickness: 1 OZ,HASL surface coating.

OPTIONS

SPD IP68 Connector.

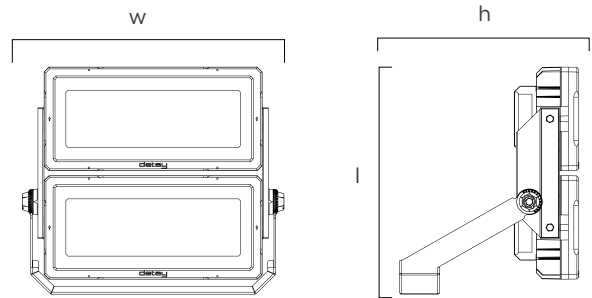

TECHNICAL SPECIFICATIONS

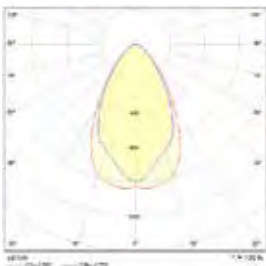

RAL CODES

Standard	Optional	Optional
RAL 9005	RAL 9016	RAL 9022

SYMMETRIC / ASYMMETRIC

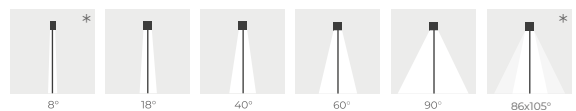

Product Code	Power	Lumen	Color Temperature	Dimensions l w h (mm)	Weight
DTY.013	800W	104000	3000-4000-6500K	651x575x446	24 kg
	1000W	130000	3000-4000-6500K	651x575x446	25 kg
	800W*	96000	3000-4000-6500K	651x575x446	24 kg
	1000W*	120000	3000-4000-6500K	651x575x446	25 kg

*for 80 CRI 3535 LED version



TOKYO



BODY

Aluminium injection body, electrostatic powder coated, 4mm tempered glass, ventilation plug.

LED

100.000 hours LED lifetime according to LM-80 and TM-21 report.

DRIVER

Constant current output, With 90% efficiency, Effective power factor regulation that is not affected by fluctuations in grid voltage, dimmable-programmable ENEC certificated IP67 Driver.

LENS

Resistant to UV rays, 93% optically efficient PMMA material lens or *PC reflector with aluminium reflective coating.

PCB

Aluminum PCB, Aluminum Base Layer / Thickness: 1L / 1.6mm. Copper Thickness: 1 OZ, HASL surface coating.

OPTIONS

SPD, IP68 Connector.

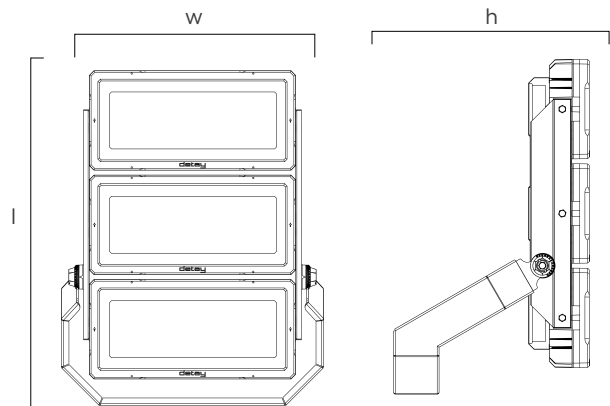

TECHNICAL SPECIFICATIONS

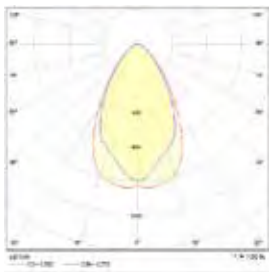

RAL CODES

Standard	Optional	Optional
RAL 9005	RAL 9016	RAL 9022

SYMMETRIC / ASYMMETRIC

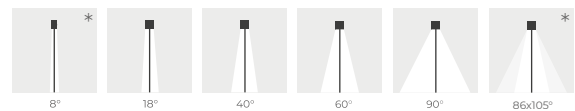

Product Code	Power	Lumen	Color Temperature	Dimensions l w h (mm)	Weight
DTY.013	1200W	156000	3000-4000-6500K	952x691x516	36 kg
	1500W	195000	3000-4000-6500K	952x691x516	38 kg
	1200W*	144000	3000-4000-6500K	952x691x516	36 kg
	1500W*	180000	3000-4000-6500K	952x691x516	38 kg

*for 80 CRI 3535 LED version



TOKYO



BODY

Aluminium injection body, electrostatic powder coated, 4mm tempered glass, ventilation plug.

LED

100.000 hours LED lifetime according to LM-80 and TM-21 report.

DRIVER

Constant current output, With 90% efficiency, Effective power factor regulation that is not affected by fluctuations in grid voltage, dimmable-programmable ENEC certificated IP67 Driver.

LENS

Resistant to UV rays, 93% optically efficient PMMA material lens or *PC reflector with aluminium reflective coating.

PCB

Aluminum PCB, Aluminum Base Layer / Thickness: 1L / 1.6mm. Copper Thickness: 1 OZ,HASL surface coating.

OPTIONS

SPD, IP68 Connector.

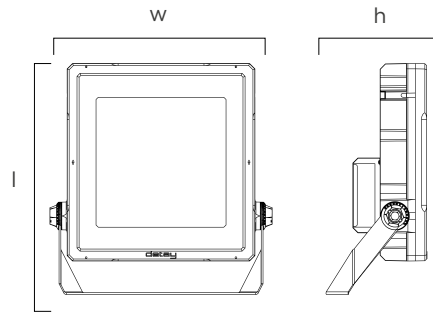

TECHNICAL SPECIFICATIONS

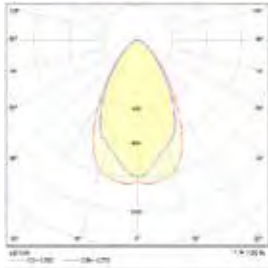

RAL CODES

Standard	Optional	Optional
RAL 9005	RAL 9016	RAL 9022

SYMMETRIC

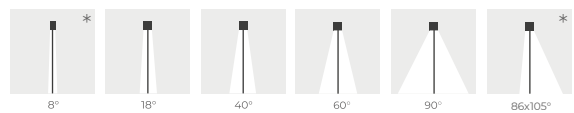

Product Code	Power	Lumen	Color Temperature	Dimensions l w h (mm)	Weight
DTY.013	600W	78000	3000-4000-6500K	507x438x217	15 kg
	600W*	72000	3000-4000-6500K	507x438x217	15 kg

*for 80 CRI 3535 LED version



TOKYO



BODY

Aluminium injection body, electrostatic powder coated, 4mm tempered glass, ventilation plug.

LED

100.000 hours LED lifetime according to LM-80 and TM-21 report.

DRIVER

Constant current output, With 90% efficiency, Effective power factor regulation that is not affected by fluctuations in grid voltage, dimmable-programmable ENEC certificated IP67 Driver.

LENS

Resistant to UV rays, 93% optically efficient PMMA material lens or *PC reflector with aluminium reflective coating.

PCB

Aluminum PCB, Aluminum Base Layer / Thickness: 1L / 1.6mm. Copper Thickness: 1 OZ,HASL surface coating.

OPTIONS

SPD, IP68 Connector.

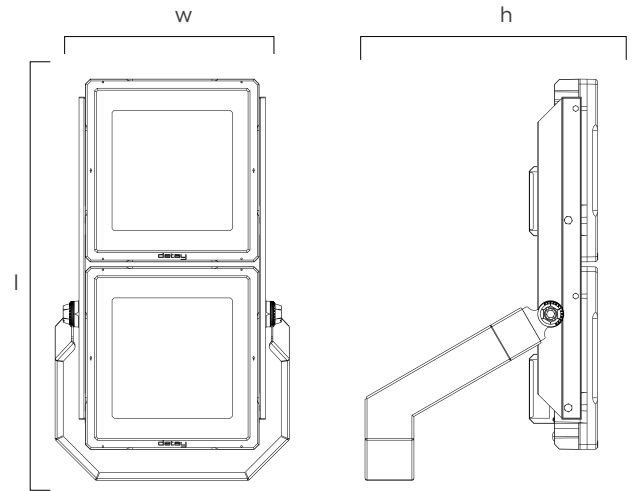

TECHNICAL SPECIFICATIONS

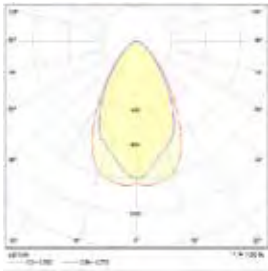

RAL CODES

Standard	Optional	Optional
RAL 9005	RAL 9016	RAL 9022

SYMMETRIC

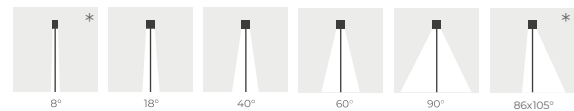

Product Code	Power	Lumen	Color Temperature	Dimensions l w h (mm)	Weight
DTY.013	1200W	156000	3000-4000-6500K	575x984x570	32 kg
	1200W*	14400	3000-4000-6500K	575x984x570	32 kg

*for 80 CRI 3535 LED version



PARIS



BODY

Aluminium injection body, electrostatic powder coated, 4mm tempered glass, ventilation plug.

LED

100.000 hours LED lifetime according to LM-80 and TM-21 report.

DRIVER

Constant current output, With 90% efficiency, Effective power factor regulation that is not affected by fluctuations in grid voltage, ENEC certificated IP67 Driver.

LENS

Resistant to UV rays, 93% optically efficient PMMA material lens.

PCB

Aluminum PCB, Aluminum Base Layer / Thickness: 1L / 1.6mm. Copper Thickness: 1 OZ,HASL surface coating.

OPTIONS

Dimmable, programmable driver, SPD, IP68 Connector.

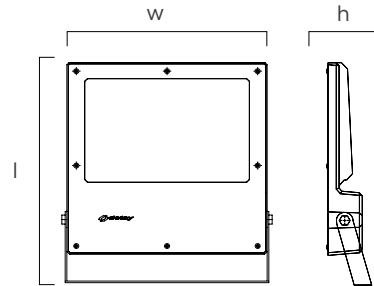

TECHNICAL SPECIFICATIONS

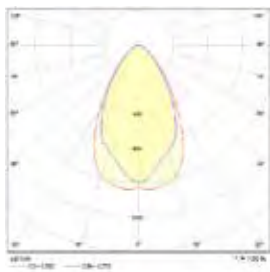

RAL CODES

Standard	Optional	Optional
RAL 9005	RAL 9016	RAL 9022

SYMMETRIC

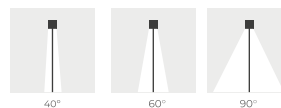

Product Code	Power	Lumen	Color Temperature	Dimensions l w h (mm)	Weight
DTY.014	100W	13000	3000-4000-6500K	386x320x63	4,4 kg
	125W	16250	3000-4000-6500K	386x320x63	4,4 kg
	150W	19500	3000-4000-6500K	386x320x63	4,4 kg
	200W	26000	3000-4000-6500K	421x360x62	5,3 kg



TİRAN



BODY

Aluminium injection body, electrostatic powder coated, 4mm tempered glass, ventilation plug.

LED

100.000 hours LED lifetime according to LM-80 and TM-21 report.

DRIVER

Constant current output, With 90% efficiency, Effective power factor regulation that is not affected by fluctuations in grid voltage, ENEC certificated IP67 Driver.

LENS

Resistant to UV rays, 93% optically efficient PMMA material lens.

PCB

Aluminum PCB, Aluminum Base Layer / Thickness: 1L / 1.6mm. Copper Thickness: 1 OZ, HASL surface coating.

OPTIONS

Dimmable, programmable driver, SPD, IP68 Connector.

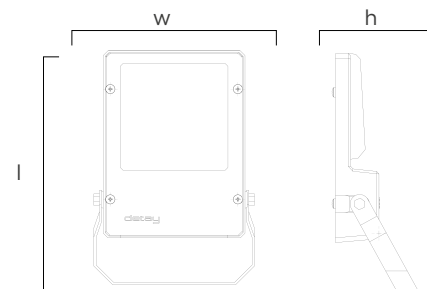

TECHNICAL SPECIFICATIONS

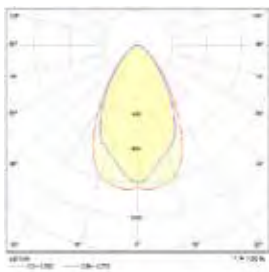

RAL CODES

Standard	Optional	Optional
RAL 9005	RAL 9016	RAL 9022

SYMMETRIC

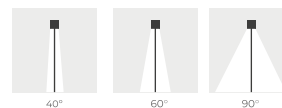

Product Code	Power	Lumen	Color Temperature	Dimensions l w h (mm)	Weight
DTY.015	30W	3900	3000-4000-6500K	250x170x46	1,2 kg
	50W	6500	3000-4000-6500K	250x170x46	1,8 kg
	60W	7800	3000-4000-6500K	253x205x46	1,8 kg
	75W	9750	3000-4000-6500K	253x205x46	1,8 kg



DAKAR



BODY

Aluminium injection body, electrostatic powder coated, 4mm tempered glass.

LED

100.000 hours LED lifetime according to LM-80 and TM-21 report.

DRIVER

Constant current output, With 88% efficiency, Effective power factor regulation that is not affected by fluctuations in grid voltage, ENEC certificated IP67 Driver.

LENS

Resistant to UV rays, 93% optically efficient PMMA material lens.

PCB

Aluminum PCB, Aluminum Base Layer / Thickness: 1L / 1.6mm. Copper Thickness: 1 OZ,HASL surface coating.

OPTIONS

Dimmable, programmable driver, SPD, IP68 Connector.

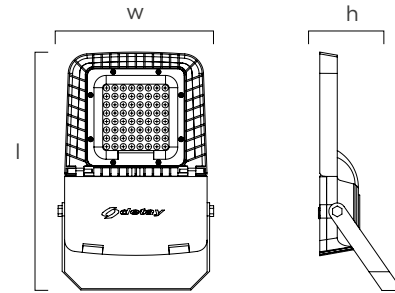

TECHNICAL SPECIFICATIONS

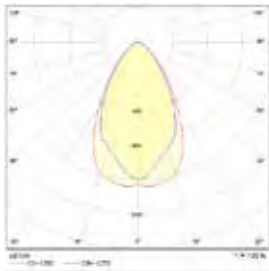

RAL CODES

Standard	Optional	Optional
RAL 9005	RAL 9016	RAL 9022

SYMMETRIC

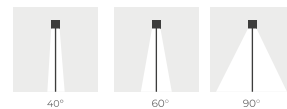

Product Code	Power	Lumen	Color Temperature	Dimensions l w h (mm)	Weight
DTY.016	30W	3900	3000-4000-6500K	349x220x90	2,5 kg
	50W	6500	3000-4000-6500K	349x220x90	2,5 kg
	60W	7800	3000-4000-6500K	349x220x90	2,5 kg



detay
LIGHTING

www.detayaydinlatma.com.tr



Emek Mahallesi, Sırdaş Sokak
No: 27/1 Sancaktepe, İstanbul/Türkiye

Phone: +90 216 602 11 41
Export: export@detayaydinlatma.com.tr

Follow us from our social media accounts



[/detayaydinlatma](https://www.instagram.com/detayaydinlatma)



[/DetayAydinlatma](https://www.facebook.com/DetayAydinlatma)



[detaylighting](https://www.linkedin.com/company/detaylighting)